



LR40 Dual Pump Controller Installation & Use Manual

ENGLISH

Contents

1	Warnings & Safety Instructions	3
1.1	Installation	3
2	Caring for the Environment	3
2.1	Disposal of Packing Material	3
2.2	Disposal of Your Old Appliance	3
2.3	Disposal of Old Batteries	3
3	Guide to the Product	4
3.1	External Features	4
3.2	Internal Features	5
4	Installation	9
4.1	Typical Installation	9
4.1.1	Emptying Waste Water Wiring Diagram	10
4.2	Backup Battery Activation	10
4.3	Float Switch Operation	10
5	Mechanical Fixing of the Product	11
6	Specification	12
7	Contact Information	12

1 Warnings & Safety Instructions

This product conforms to current safety requirements. Inappropriate use can lead to personal injury, injury to others, and/or damage to property.

Please read the following operating & installation instructions before installing this product. The following document contains important information on the safety of installation, use, and maintenance of the product. This information will prevent hazards from arising.

Keep this document in a safe place for further use.

1.1 Installation

- When the cover of the product is removed, ensure that the incoming external voltage source is isolated/removed.
- Take extra care when connecting wires to the terminal blocks in the product. Avoid lengthy insulated cables and ensure that there are no loose cable strands. It is advised to terminate stranded cables with ferrules.
- Take extra care when installing this product where the audio alert may be impeded. Please note that the environment the product is situated will affect the audio alert volume and sound quality.
- Installation of this product should be carried out by a competent person.

2 Caring for the Environment

2.1 Disposal of Packing Material

The packaging is designed to protect the product from damage during transportation. The packaging materials used are selected from materials that are environmentally friendly for disposal and should be recycled.

Recycling the packaging reduces the use of raw materials in the manufacturing process and also reduces the amount of waste in landfill sites.

2.2 Disposal of Your Old Appliance

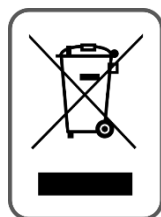

Electronic and electrical appliances contain many valuable materials. These materials and compounds could be hazardous to your health and the environment if disposed of or handled incorrectly.

Please do not dispose of your old product with your household waste.

Instead, please make use of the official designated collection and disposal points of your region or country, or return the unit to the manufacturer or distributor using the contact information provided at the back of this document.

2.3 Disposal of Old Batteries

- Do **NOT** dispose of old batteries in general waste.

Depending on the variant of the product, it may contain lithium-ion battery cells. Should the function of the battery be depleted over time, or damage has occurred to the battery, then the battery must be disposed of and a replacement battery fitted. You are legally obliged (depending on the country) to remove any old batteries and take them to a suitable collection point.

Old batteries contain valuable raw materials which can be recycled. Disposing of batteries separately makes them easier to handle and recycle.

3 Guide to the Product

3.1 External Features



1 User Interface:

Test button - activates alarm and alarm outputs

Power indicator - Constant blue when mains power is connected.

Alarm indicator - flashes red when alarm is active

For the backup battery variant, the indicator will flash red when the incoming power is removed.

High level indicator

Pump 1 over current indicator

Pump 1 over temperature indicator

Pump 2 over current indicator

Pump 2 over temperature indicator

Pump 1 active indicator

Pump 2 active indicator

GSM signal indicator

Setup button - for the GSM alarm setup, this feature is not active on the basic unit

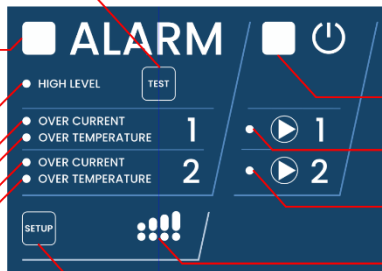

2 Isolation Switch

The front fascia of the product is not removable unless the switch is in the OFF position.

WARNING The incoming mains is still live at the input side of the isolation switch when in the off position.

3 Audio Alarm Buzzer

Sounds every 500ms when the alarm is activated. The Mute Switch must be in the 1 position for the buzzer to operate.

4 Audio Alarm Mute Switch



Audio alarm unmuted

Audio alarm muted

5 Pump Control Switches

Pump manual mode - This will switch the pump on

WARNING The pump is not protected in manual mode

Pump Off - Resets over-current & over-temperature alarm

Pump automatic mode - The pump controller will automatically regulate the liquid level depending on the float switches' positions and their status

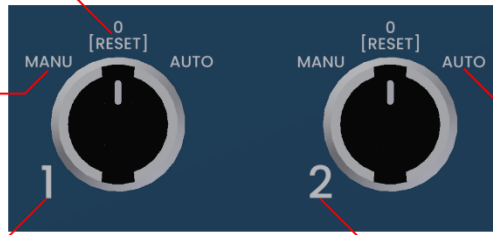

Pump 1

Pump 2

3.2 Internal Features

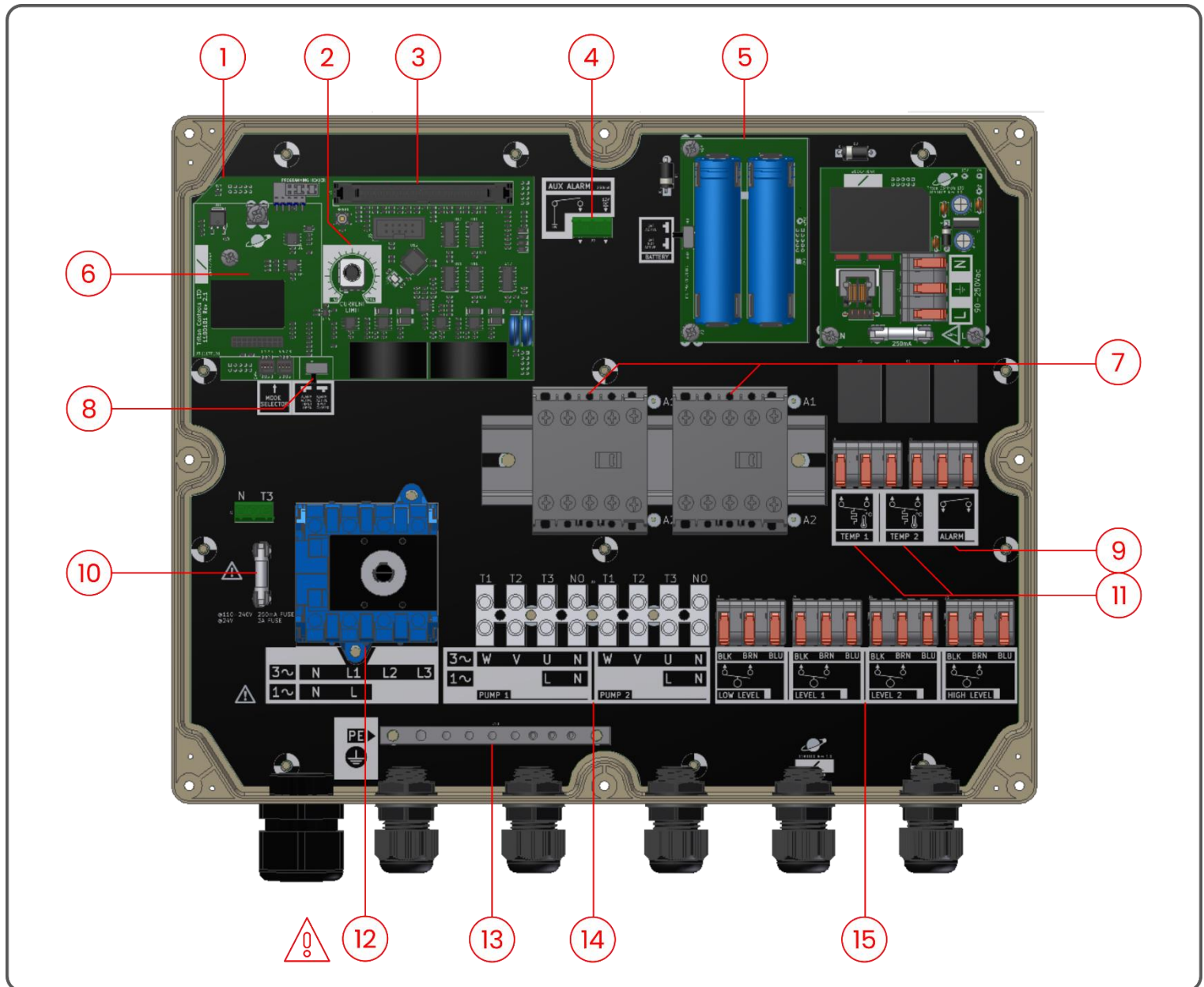

1 Processor Module

LED internal power indicator:

The LED indicator is not illuminated for the BASIC unit while the panel lid is open. If the LED is illuminated, switch off the power to the unit immediately.

For the BATTERY unit, the LED indicator will be illuminated when the backup battery module [5] is activated. It is not illuminated while the backup battery module is not active. If it is illuminated with the lid open and the backup battery module not activated, switch off the power to the unit immediately.

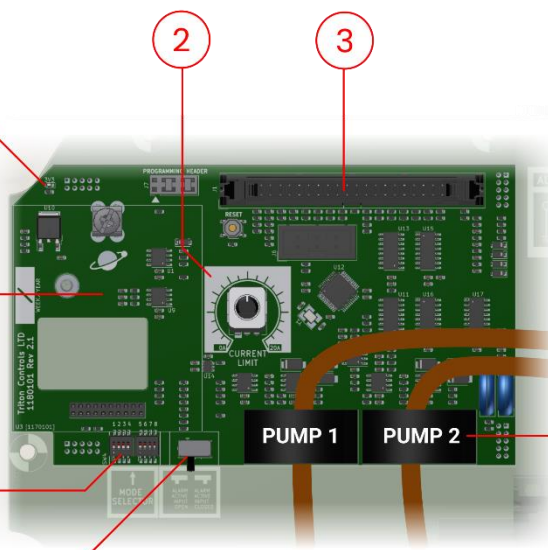

Current sensors for over-current protection. The Live for single phase or L3 for three-phase must go through the current sensors.

2 Current Limit

Adjust the current limit dial to the required setting. The current limit is set for both pump 1 and pump 2 and is settable between 0-20A.

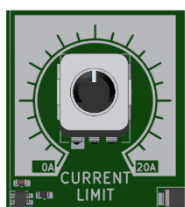

3 Display Connector

WARNING Ensure the ribbon cable is firmly fitted into both the display connector on the processor module and the display panel.

4 Auxiliary Alarm

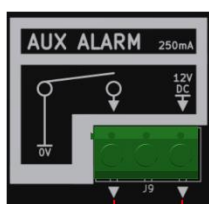

0V SWITCHED NEGATIVE 12Vdc

Optional Accessories can be fitted to the auxiliary alarm connector J9. E.g., an external beacon.

The auxiliary alarm provides a 12Vdc 250mA output during an activated alarm.

NOTE: External circuitry connected to the auxiliary alarm will affect the backup battery performance.

ALARM INACTIVE

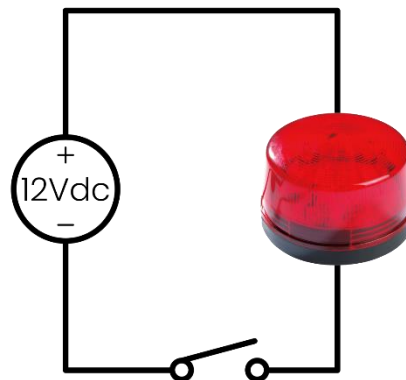

ALARM ACTIVE

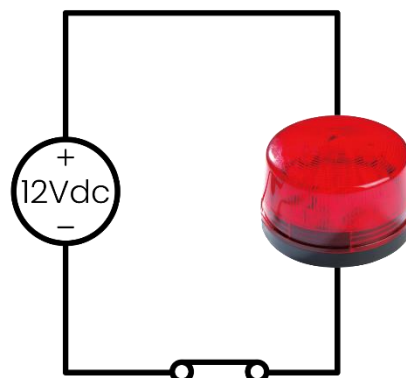

5 Backup Battery

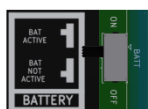

During installation, activate the battery module by setting the battery switch to active. The LED internal power indicator will illuminate once the backup battery circuit is active.

6 GSM Module Upgrade Port

[FITTED FOR GSM VARIANT]

The LR30-GSM Module is an optional upgrade. the upgrade allows text messages to be sent upon activation of the alarm.



7 Contactors 240V Coil



8 Float Input Config Selector

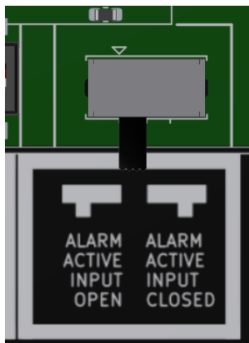

The float switch inputs can be activated open circuit or closed circuit.

To choose open circuit activation, move the switch position to the left "ALARM ACTIVE INPUT OPEN".

To choose closed circuit activation, move the switch position to the right "ALARM ACTIVE INPUT CLOSED".

All float switch inputs are affected. Pressure switches are not affected on Function-3.

EXAMPLE:

The high-level alarm is active in both setups below

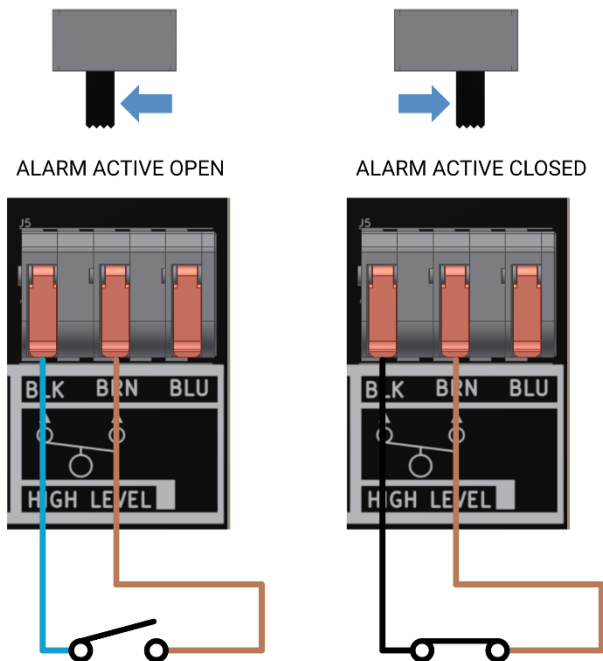

NOTE: Pump wiring example text at the connectors will be incorrect for ACTIVE OPEN

9 Volt Free Alarm Output

ALARM INACTIVE

ALARM ACTIVE

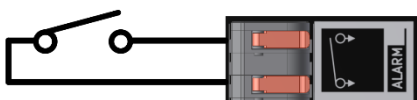

Rating:
10A @ 240V

10 Fuse 250mA for 240/400Vac
3A for 24Vac

12 Isolator Switch

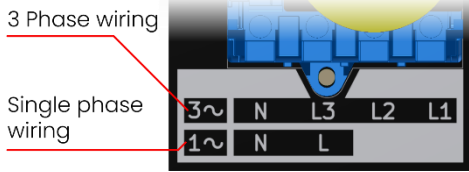

13 Earth Terminal Block

14 Pump Output Connector

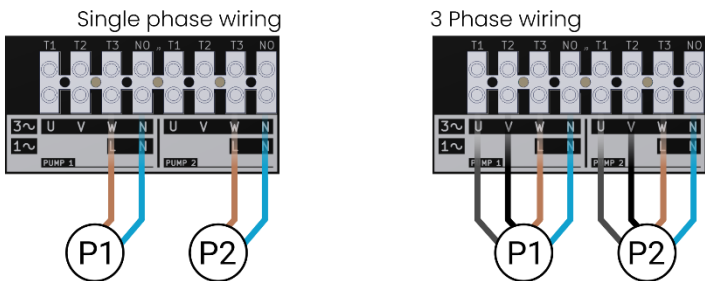

11 Over-Temperature Sensors

The pumps have the option for over-temperature alarms via the TEMP 1 & 2 terminals.

When the inputs are open circuit the over-temperature alarm is activated and the pump will cease running. The other pump will be activated, if it is not already and both pumps are set to "AUTO".

The unit is supplied with pre-fitted temperature sensor link wires. Leave these wires in place if the over-temperature alarm is not required.

EXAMPLE:

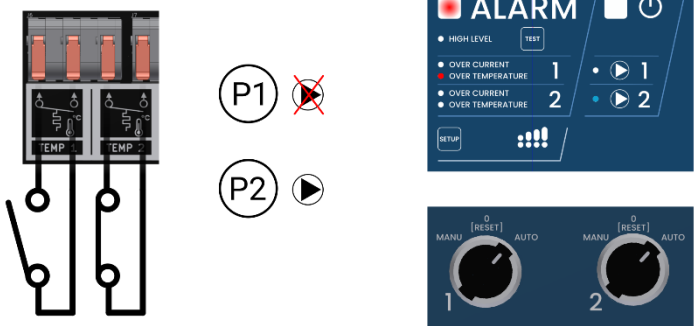

15 Float Input Terminals

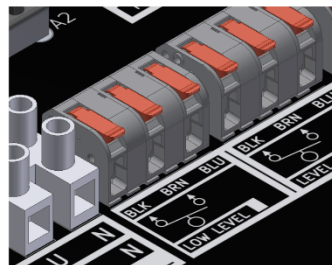
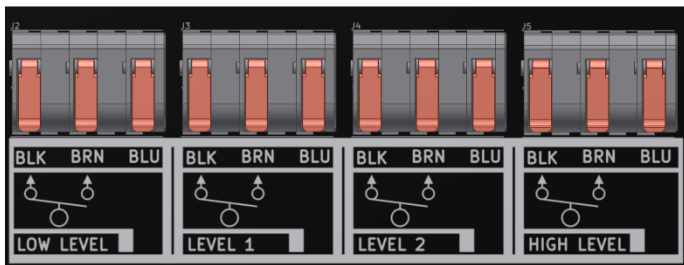

The float input terminals use quick-connect WAGO connectors for tool-free installation.

Each connector is labelled with the wire colours for Function-1 using ACTIVE CLOSED inputs on the Float Input Config Selector.

BLU is not internally connected and is used for the spare float switch wire.

BLK & BRN are the switched input with the circuit shown below:

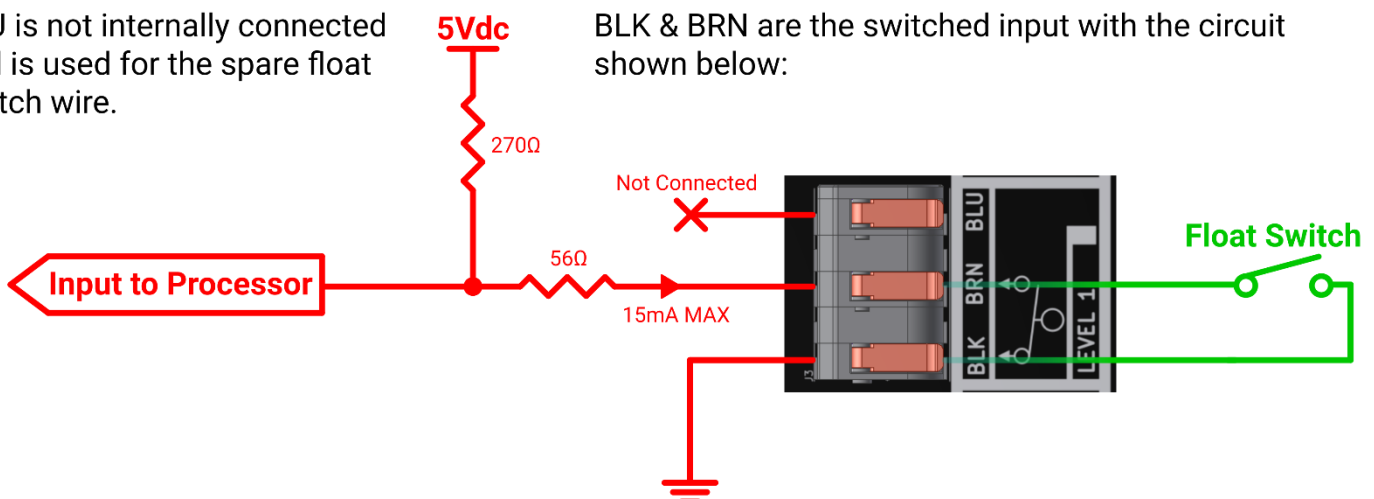

4 Installation

4.1 Typical Installation

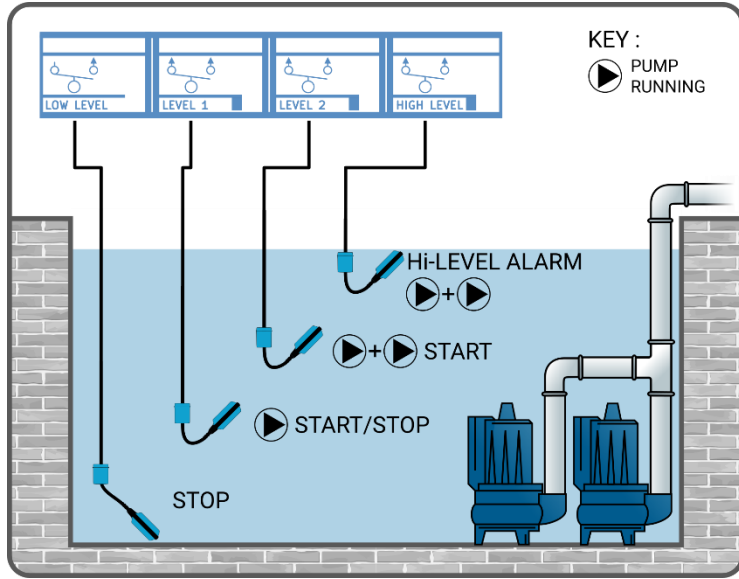

- A simple system for emptying a waste water tank
- Alternating pumps on activation
- Float switch activated closed circuit

Low Level	Level 1	Level 2	High Level	Rising	Falling

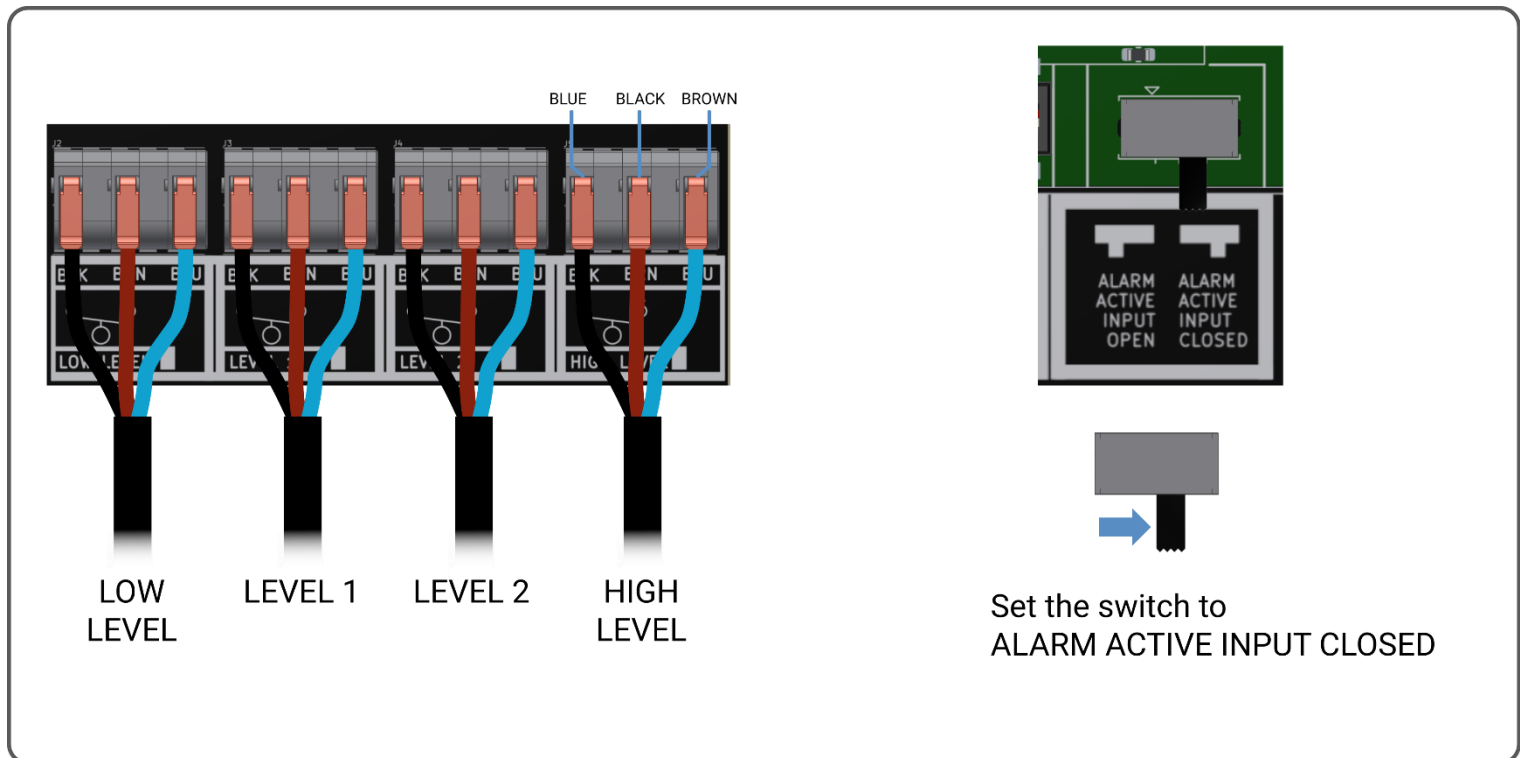

4.1.1 Emptying Waste Water Wiring Diagram

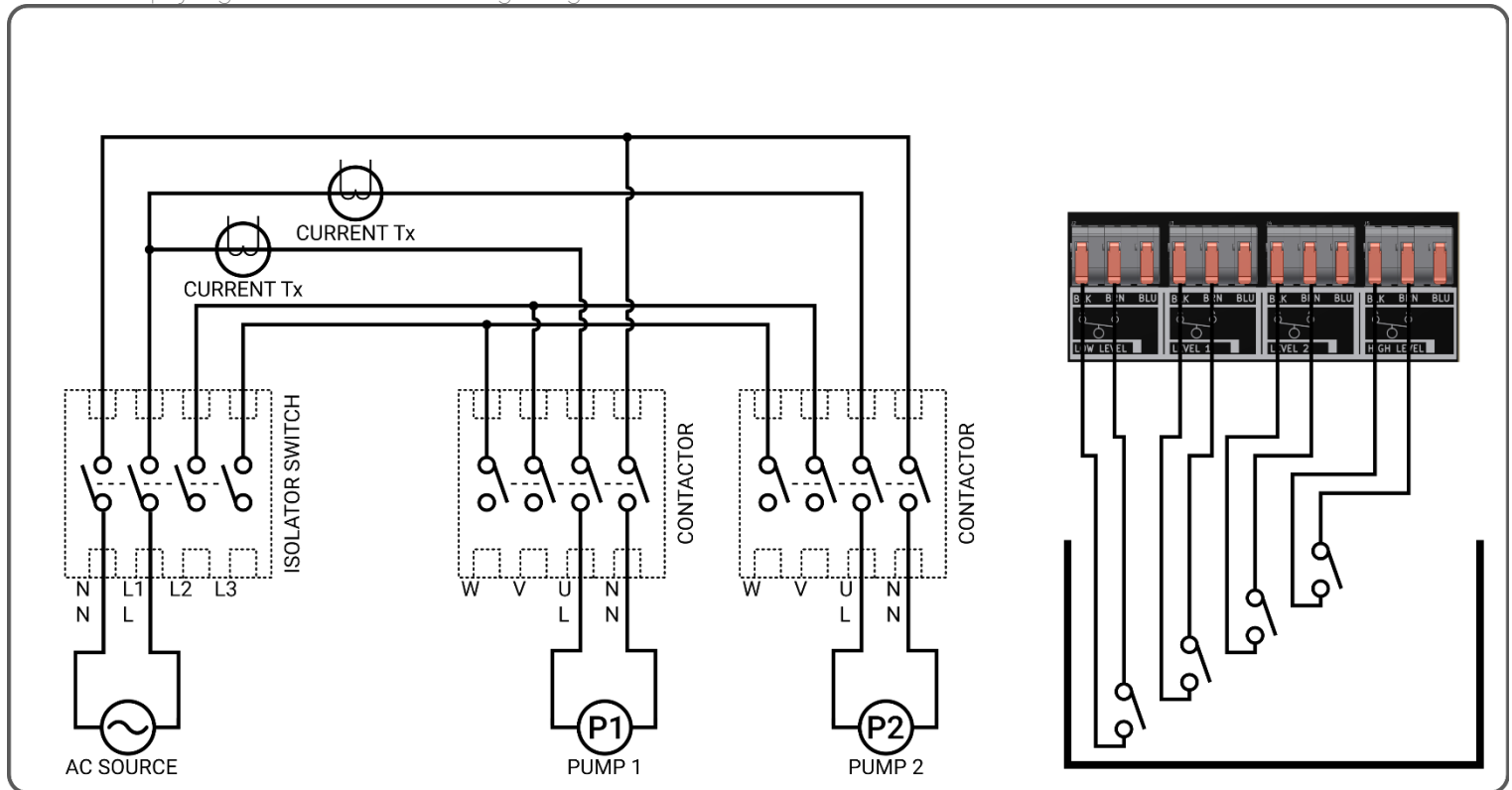

4.2 Backup Battery Activation

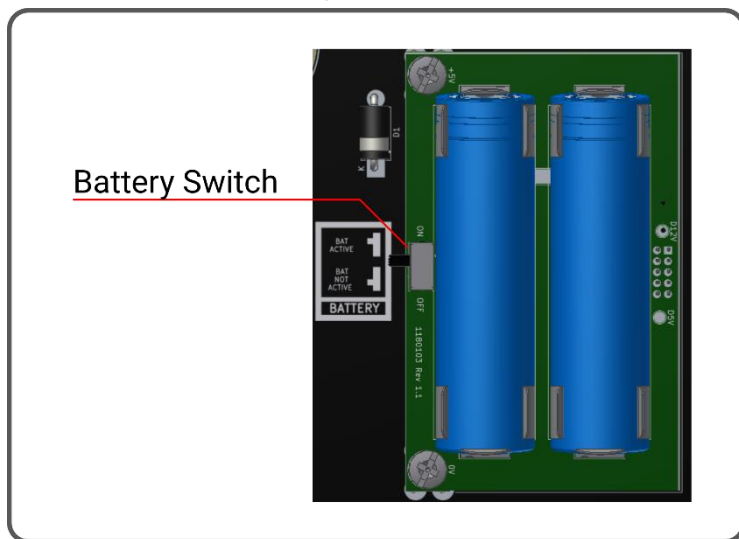

NOTE: The pumps will not operate during a power outage.

1. When installing a backup battery unit first ensure the power to the unit is isolated.
2. Connect the system to the desired float switch configuration.
3. Set the battery switch to "BAT ACTIVE".

NOTE: the processor power LED will now be illuminated

4. The panel will be in a power outage alarm state.
5. Fit the front panel to the unit.
6. Set the isolator switch to "ON" and the power outage alarm will be deactivated.

The alarm indicator, auxiliary alarm, and volt-free output relay are all operational while the backup battery is running.

4.3 Float Switch Operation

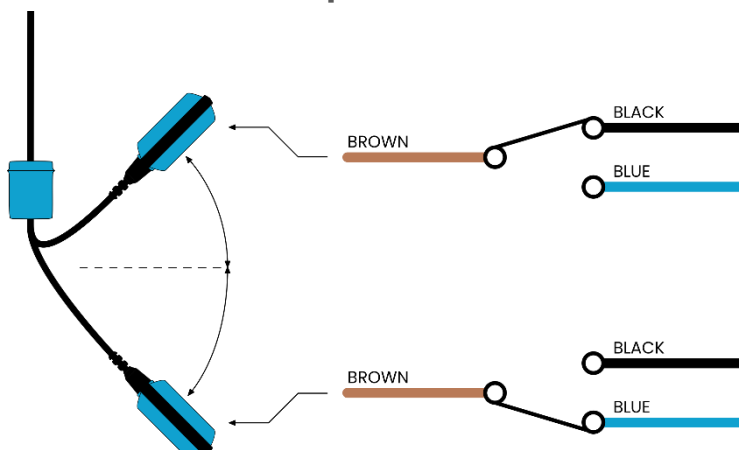

NOTE: Float switches must be tethered, externally weighted, or internally weighted to operate correctly. Please check the manufactures data when installing float switches.

5 Mechanical Fixing of the Product

Step 1:
Align the drill template and drill the holes indicated

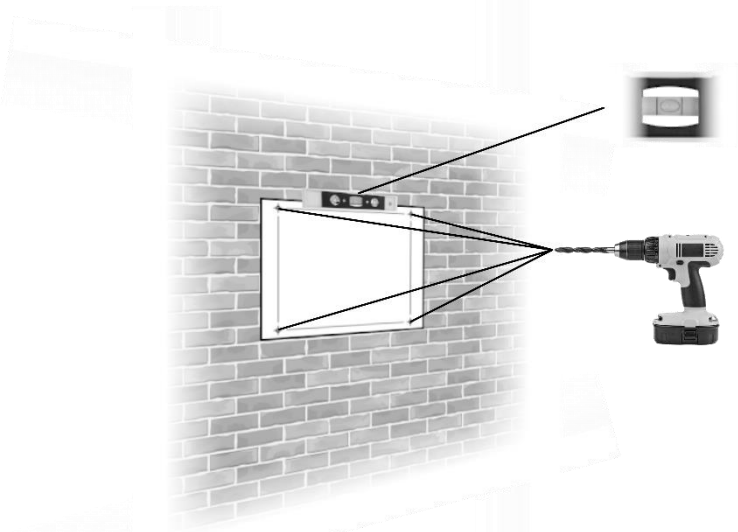

Step 2:
Use wall plugs if required

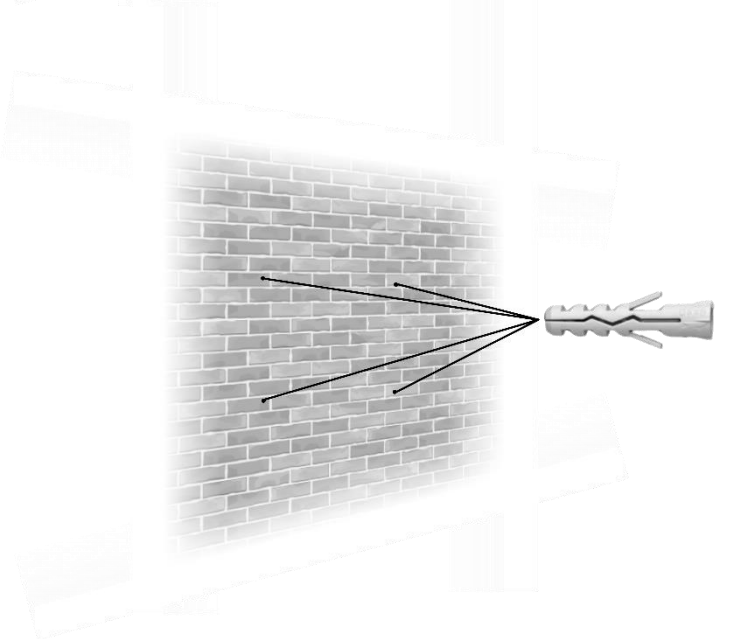

Step 3:
Using the internal screw holes, fit the unit to the wall

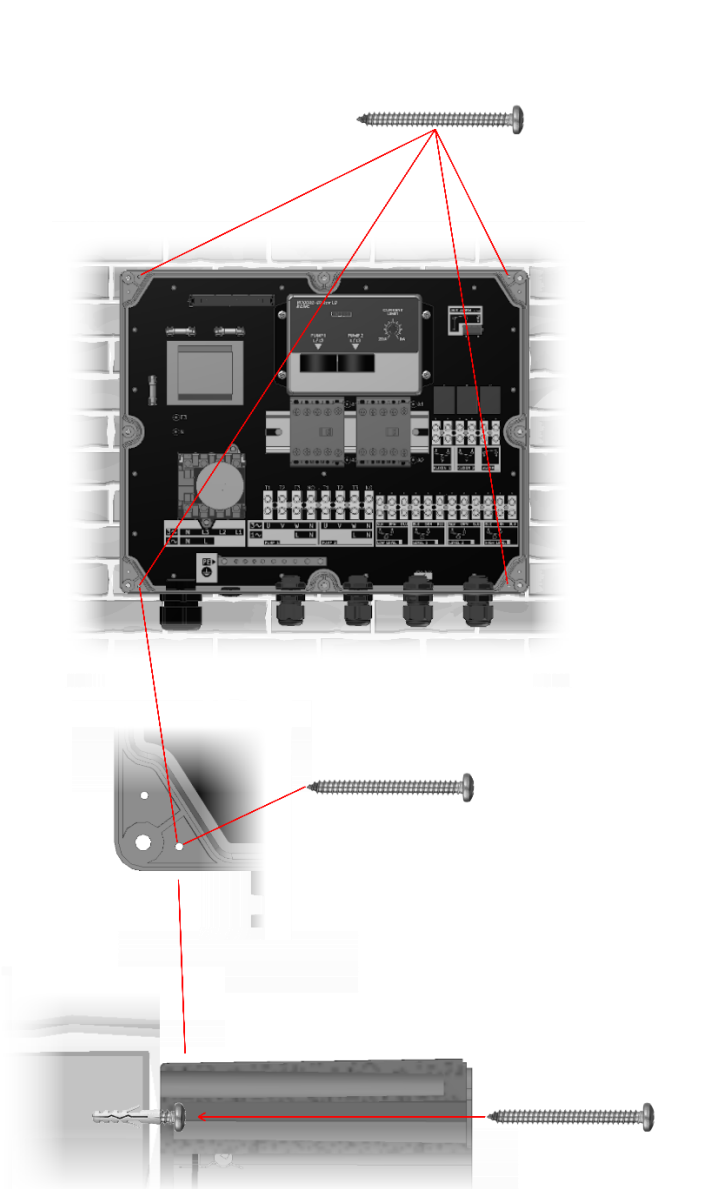

6 Specification

	Rating
Enclosure	
IP rating	IP65
Dimensions [Total]	340x300x120mm
Weight	3.7kg
Cable Gland Configuration	
Supply	1 x M25
Pumps/input/outputs	6 to 9 x M16
Supply Voltage	
240V Variant <small>[single & three phase]</small>	230Vac I/III or 400Vac III -20% +30% [50/60Hz]
24V Variant	24Vac/dc ±10% [50/60Hz]
Pump Output Current	1-12A each pump
Pump Protection	<ul style="list-style-type: none">• Overcurrent trip• Overheating trip• Alternating pumps
Over Current Setting	Settable 1-20A
Switched Input	[Float or Pressure Switch]
Max cable length	200m
Switched voltage	5Vdc
Max switched current	10mA
Audio Output	
Max sound level	105dB 3kHz 12Vdc
Visual Alarm Output	Red flashing LED
Output Relay	
Relay topology	NO, Closed on alarm active
Max current	10A @250Vac
Max Voltage	250Vac
Auxiliary Output	
Voltage	12Vdc
Max Current	250mA [3W]
Terminal Capacity	
Inputs	0.2-4mm ² <small>[tool free wire fitting]</small>
Pump terminals	0.2-10mm ² <small>[screw terminal]</small>
Ambient Temperature	-10°C to +55°C
Backup Battery <small>[Battery variant only]</small>	72 hours max run time

7 Contact Information

ADDRESS: Triton Controls Ltd
Randolph Industrial Estate
Evenwood
Bishop Auckland
DL14 9SJ

TEL: +44 (0) 1388 833000
EMAIL: info@tritoncontrols.co.uk
WEBSITE: www.tritoncontrols.co.uk